

Needle Roller Bearings Inner Ring

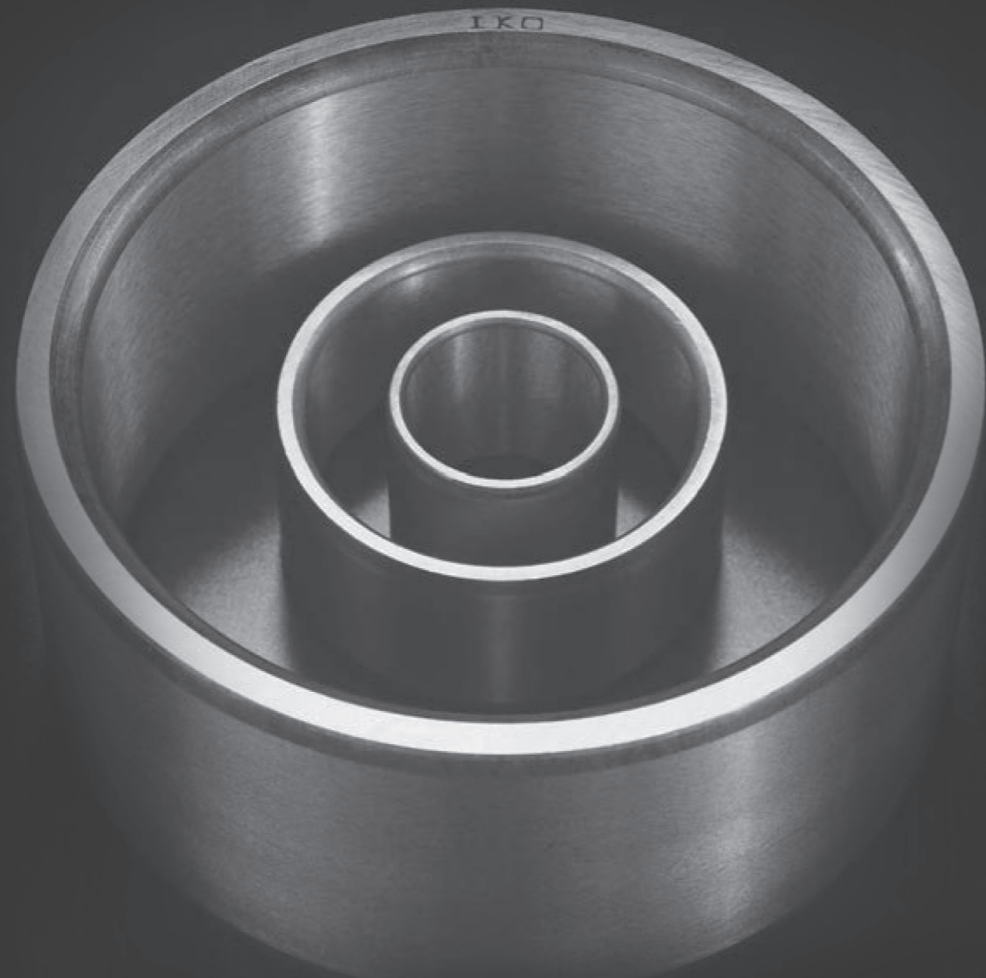

1.7. Inner Rings Needle Roller Bearings

Inner Ring은 열 처리 후 고정밀도로 연삭가공을 하였습니다. 일반적으로 니들 롤러 베어링은 축을 열처리, 연삭가공하여 궤도면으로 사용하지만 축의 표면을 규정 경도나 조도로 가공

할 수 없는 경우 이 Inner Ring을 사용합니다. 또한 Inner Ring은 Bushing으로 사용할 수도 있고 재가공할 필요도 없어 경제적 입니다.

Inner Ring

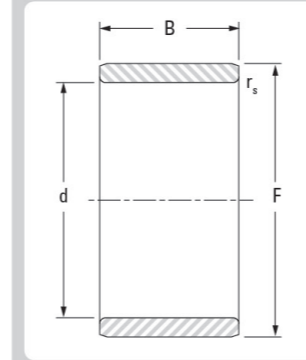

JR
LRT, IRT

허용공차

Inner Ring 내경의 허용 공차는 일반적으로 JIS Class0을 따릅니다. IRT의 외경 공차는 g5 입니다.

LRT의 외경 공차는 아래 표를 참조하여 주시기 바랍니다.

• LRT 외경 공차

단위: μm

d 내경(mm)		F 외경(mm)											
		3 < F ≤ 6		6 < F ≤ 10		10 < F ≤ 18		18 < F ≤ 30		30 < F ≤ 50		50 < F ≤ 80	
초과	미만	상한	하한	상한	하한	상한	하한	상한	하한	상한	하한	상한	하한
-	24	-10	-27	-7	-23	-4	-18	0	-12				
24	30							0	-12	+5	-4		
30	40									0	-9		
40	50									-5	-19	0	-11
50	65											-10	-21
65	80											-10	-26

d 내경(mm)		F 외경(mm)											
		80 < F ≤ 120		120 < F ≤ 180		180 < F ≤ 250		250 < F ≤ 315		315 < F ≤ 400		400 < F ≤ 500	
초과	미만	상한	하한	상한	하한	상한	하한	상한	하한	상한	하한	상한	하한
65	80	-4	-17										
80	100	-14	-27										
100	120	-14	-32	-7	-22								
120	140			-17	-37								
140	160			-27	-52								
160	180					-25	-46						
180	200					-40	-66						
200	225					-55	-86						
225	250							-54	-87				
250	280							-69	-107				
280	315									-68	-107		
315	355									-83	-127		
355	400									-128	-182	-122	-172
400	450											-142	-202
450	500											-152	-222

1.7 Inner Ring

Needle Roller Bearings

미리계열

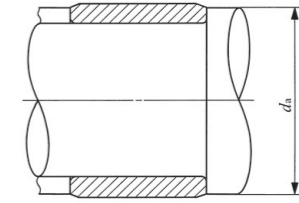
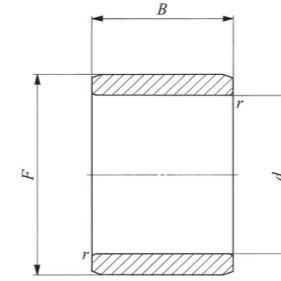

축지름 (mm)	Inner Rings		d (mm)	F (mm)	B (mm)	조합 Bearings	
	Koyo	IKO				Koyo	IKO
5	-	LRT 5710	5	7	10	-	RNA495
	JR 5×8×8 JS1	-	5	8	8	-	-
	JR 5×8×12	LRT 5812	5	8	12	NK8/12	TAF81512
6	-	LRT 5816	5	8	16	-	TAF81516
	-	LRT 6810	6	8	10	-	RNA496
	JR 6×9×8 JS1	-	6	9	8	-	-
	JR 6×9×12	LRT 6912	6	9	12	NK9/12	TAF91612
	JR 6×9×16	LRT 6916	6	9	16	NK9/16	TAF91616
	JR 6×10×10	LRT 61010	6	10	10	RNAO101710	RNAF101710
	JR 6×10×10 JS1	-	6	10	10	-	-
7	JR 6×10×12 JS1	-	6	10	12	-	-
	-	LRT 7910	7	9	10	-	RNA497
	JR 7×10×10.5	IRT 710	7	10	10.5	HK1010	TA1010Z TLA1010Z
	JR 7×10×12	LRT 71012	7	10	12	NK10/12	RNAO102012 TAF101712 RNAF102012
	-	IRT 712	7	10	12.5	-	TA1012Z TLA1012Z
	-	IRT 715	7	10	15.5	-	TA1015Z TLA1015Z
8	JR 7×10×16	LRT 71016	7	10	16	NK10/16	NAXK10 TAF101716 NAX1023
	-	LRT 81011	8	10	11	-	RAN498
	JR 8×12×10	-	8	12	10	-	-
	JR 8×12×10 JS1	-	8	12	10	-	-
	JR 8×12×10.5	IRT 810	8	12	10.5	HK1210	TLA1210Z YTL1210
	JRZ 8×12×12 JS1	-	8	12	12	-	-
9	JR 8×12×12.5	IRT 812	8	12	12.5	HK1212	TA1212Z TLA1212Z
	-	IRT 815	8	12	15.5	-	TA1215Z
	-	LRT 91211	9	12	11	-	RNA499
	JR 9×12×12	LRT 91212	9	12	12	NK12/12	RNAO122212 TAF121912 RNAF122212
	JR 9×12×16	LRT 91216	9	12	16	NK12/16	NAXK12 TAF121916 NAX 223

축지름 (mm)	Inner Rings		d (mm)	F (mm)	B (mm)	조합 Bearings	
	Koyo	IKO				Koyo	IKO
10	JR 10×13×12.5	IRT 1012	10	13	12.5	HK1312	TLA1312Z
	JR 10×14×11 JS1	-	10	14	11	-	-
	JR 10×14×12	LRT 101412	10	14	12	RNAO142612	RNAF142612
	JR 10×14×12 JS1	-	10	14	12	-	-
	-	IRT 1012-2	10	14	12.5	-	TLA1412Z
	JR 10×14×13	LRT 101413	10	14	13	RNA4900 RNAO142213	RNA4900 RNAF142213
	JRZ 10×14×14 JS1	LRTZ 101414	10	14	14	RNA4900.2RS	RNA4900UU
	JR 10×14×16	LRT 101416	10	14	16	NK14/16	TAF142216
	-	IRT 1016-2	10	14	16.5	-	TA1416Z TLA1416Z
	JR 10×14×20	LRT 101420	10	14	20	NK14/20 RNAO142220	TAF142220 RNAFW142220
	-	IRT 1020-2	10	14	20.5	-	TA1420Z
	-	IRT 1010-1	10	15	10.5	-	TA1510Z
	-	IRT 1012-1	10	15	12.5	-	TA1512Z TLA1512Z
	-	IRT 1015-1	10	15	15.5	-	TA1515Z
	-	IRT 1020-1	10	15	20.5	-	TA1520Z
-	IRT 1025-1	10	15	25.5	-	TA1525Z	

1.7 Inner Ring

Needle Roller Bearings

미리계열

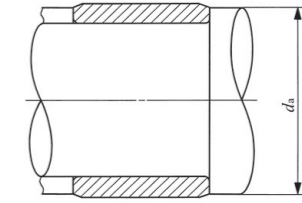
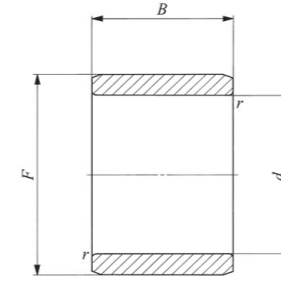

축지름 (mm)	Inner Rings		d (mm)	F (mm)	B (mm)	조합 Bearings			
	Koyo	IKO				Koyo		IKO	
12	JR 12×15×12.5	IRT 1212	12	15	12.5	HK1512		TA1512Z	TLA1512Z
	JR 12×15×16	LRT 121516	12	15	16	NAXK15	NAXR15	NAX1523	NBX1523
	JR 12×15×16.5	IRT 1216	12	15	16.5	HK1516		TLA1516Z	
	JR 12×15×18.5	-	12	15	18.5	-		-	-
	JR 12×15×22.5	IRT 1222	12	15	22.5	HK1522		TLA1522Z	
	JR 12×16×12	LRT 121612	12	16	12	RNAO162812		RNAF162812	
	JR 12×16×12 JS1	-	12	16	12	-		-	-
	-	IRT 1212-1	12	16	12.5	-		TLA1612Z	
	JR 12×16×13	LRT 121613	12	16	13	RNA4901	RNAO162413	RNA4901	RNAF162413
	JRZ 12×16×14 JS1	LRTZ 121614	12	16	14	RNA4901.2RS		RNA4901UU	
	JR 12×16×16	LRT 121616	12	16	16	NK16/16		TAF162416	
	-	IRT 1216-1	12	16	16.5	-		TA1616Z	TLA1616Z
	JR 12×16×20	LRT 121620	12	16	20	NK16/20	RNAO162420	TAF162420	RNAFW162420
	-	IRT 1220-1	12	16	20.5	-		TA1620Z	
	JR 12×16×22	LRT 121622	12	16	22	RNA6901		RNA6901	
	-	IRT 1222-1	12	16	22.5	-		TLA1622Z	
-	LRTZ 121623	12	16	23	-		RNA6901UU		
-	IRT 1215-2	12	17	15.5	-		TA1715Z	YT1715	
-	IRT 1220-2	12	17	20.5	-		TA1720Z		
-	IRT 1225-2	12	17	25.5	-		TA1725Z	YT1725	
14	JR 14×17×17	LRT 141717	14	17	17	NAXK17	NAXR17	NAX1725	NBX1725

축지름 (mm)	Inner Rings		d (mm)	F (mm)	B (mm)	조합 Bearings			
	Koyo	IKO				Koyo		IKO	
15	-	IRT 1512	15	18	12.5	-		TLA1812Z	
	JR 15×18×16.5	IRT 1516	15	18	16.5	HK1816		TLA1816Z	
	-	IRT 1517	15	18	17.5	-		TA1817Z	
	-	IRT 1519	15	18	19.5	-		TA1819Z	
	-	IRT 1520	15	18	20.5	-		TA1820Z	
	-	IRT 1525	15	18	25.5	-		TA1825Z	
	JR 15×19×16	LRT 151916	15	19	16	NK19/16		TAF192716	
	-	IRT 1516-1	15	19	16.5	-		TA1916Z	
	JR 15×19×20	LRT 151920	15	19	20	NK19/20		TAF192720	
	-	IRT 1520-1	15	19	20.5	-		TA1920Z	
	JR 15×20×12	LRT 152012	15	20	12	RNAO203212		RNAF203212	
	JR 15×20×12JS1	-	15	20	12	-		-	-
	JR 15×20×13	LRT 152013	15	20	13	RNA4902	RNAO202813	RNA4902	RNAF202813
	JRZ 15×20×14JS1	LRTZ 152014	15	20	14	RNA4902.2RS		RNA4902UU	
	-	IRT 1515-2	15	20	15.5	-		TA2015Z	YT2015
	JR 15×20×16	-	15	20	16	-		-	-
	-	LRT 152020	15	20	20	-		TR203320	
	-	LRTZ 152020	15	20	20	-		GTR203320	
	-	IRT 1520-2	15	20	20.5	-		TA2020Z	TA202820Z
	JR 15×20×23	LRT 152023	15	20	23	RNA6902		RNA6902	
	-	LRTZ 152024	15	20	24	-		RNA6902UU	
	-	IRT 1525-2	15	20	25.5	-		TA2025Z	YT2025
	JR 15×20×26	LRT 152026	15	20	26	RNAO202826		RNAFW202826	
	-	IRT 1530-2	15	20	30.5	-		TA2030Z	TLA2030Z

1.7 Inner Ring

Needle Roller Bearings

미리계열

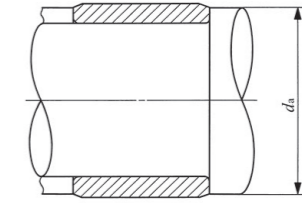
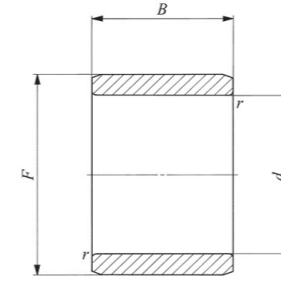

축지름 (mm)	Inner Rings		d (mm)	F (mm)	B (mm)	조합 Bearings	
	Koyo	IKO				Koyo	IKO
17	JR 17×20×16.5	IRT 1716	17	20	16.5	HK2016	TLA2016Z
	JR 17×20×20	-	17	20	20	NAXK20	NAXR20
	-	LRT 172020	17	20	20.5	-	NAX2030 NBX2030
	JR 17×20×20.5	IRT 1720	17	20	20.5	HK2020	TA2020Z TA202820Z
	JR 17×20×30.5	IRT 1730	17	20	30.5	HK2030	TA2030Z TLA2030Z
	JR 17×21×16	LRT 172116	17	21	16	NK21/16	TAF212916
	-	IRT 1716-1	17	21	16.5	-	TA2116Z YT2116
	JR 17×21×20	LRT 172120	17	21	20	NK21/20	TAF212920
	-	IRT 1720-1	17	21	20.5	-	TA2120Z YT2120
	-	IRT 1710-2	17	22	10.5	-	TA2210Z
	JR 17×22×13	LRT 172213	17	22	13	RNA4903	RNAO223013 RNA4903 RNAF223013
	-	LRTZ 172214	17	22	14	-	RNA4903UU
	-	IRT 1715-2	17	22	15.5	-	TA2215Z
	JR 17×22×16	LRT 172216	17	22	16	RNAO223516	RNAF223516
	JR 17×22×16 JS1	-	17	22	16	-	-
	JR 17×22×16 JS1	-	17	22	16	-	-
	-	IRT 1716-2	17	22	16.5	-	TA223016Z TLA2216Z
	-	IRT 1720-2	17	22	20.5	-	TA2220Z TA223020Z
	JR 17×22×23	LRT 172223	17	22	23	RNA6903	RNA6903
	-	LRTZ 172224	17	22	24	-	RNA6903UU
	-	LRT 172225	17	22	25.5	-	TR223425
	-	LRTZ 172225	17	22	25.5	-	GTR223425
	-	IRT 1725-2	17	22	25.5	-	TA2225Z
	JR 17×22×26	LRT 172226	17	22	26	RNAO223026	RNAFW223026
	-	IRT 1730-2	17	22	30.5	-	TA2230Z
	JR 17×22×32	LRT 172232	17	22	32	RNAO223532	RNAFW223532

축지름 (mm)	Inner Rings		d (mm)	F (mm)	B (mm)	조합 Bearings	
	Koyo	IKO				Koyo	IKO
20	JR 20×24×16	LRT 202416	20	24	16	NK24/16	TAF243216
	-	IRT 2016	20	24	16.5	-	TA243216Z YT243216
	JR 20×24×20	LRT 202420	20	24	20	NK24/20	TAF243220
	-	IRT 2020	20	24	20.5	-	TA2420Z TA243220Z
	-	IRT 2028	20	24	28.5	-	TA2428Z YT2428
	-	IRT 2010-1	20	25	10.5	-	TA2510Z YT2510
	-	IRT 2015-1	20	25	15.5	-	TA2515Z YT2515
	JR 20×25×16	LRT 202516	20	25	16	RNAO253716	RNAF253716
	JR 20×25×16 JS1	-	20	25	16	-	-
	JR 20×25×17	LRT 202517	20	25	17	RNA4904	RNAO253517 RNA4904 RNAF253517
	JRZ 20×25×18 JS1	LRTZ 202518	20	25	18	RNA4904.2RS	RNA4904UU
	JR 20×25×20	-	20	25	20	NAXK25	NAXR25
	-	LRT 202520	20	25	20.5	-	TR253820 NAX/NBX2530
	-	LRTZ 202520	20	25	20.5	-	GTR253820
	JR 20×25×20.5	IRT 2020-1	20	25	20.5	HK2520	TA2520Z TLA2520Z
	-	LRT 202525	20	25	25.5	-	TR253825
	-	LRTZ 202525	20	25	25.5	-	GTR253825
	-	IRT 2025-1	20	25	25.5	-	TA2525Z YT2525
	JR 20×25×26	LRT 202526	20	25	26	RNAO253526	RNAFW253526
	JR 20×25×26.5	IRT 2026-1	20	25	26.5	HK2526	TLA2526Z YTL2526
	JR 20×25×30	LRT 202530	20	25	30	RNA6904	RNA6904
	-	IRT 2030-1	20	25	30.5	-	TA2530Z
	-	LRTZ 202531	20	25	31	-	RNA6904UU
	JR 20×25×32	LRT 202532	20	25	32	RNAO253732	RNAFW253732
	JR 20×25×38.5	IRT 2038-1	20	25	38.5	HK2538	TLAW2538Z
	JR 20×28×20	-	20	28	20	NKS28A	-

1.7 Inner Ring

Needle Roller Bearings

미리계열

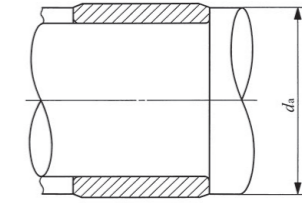
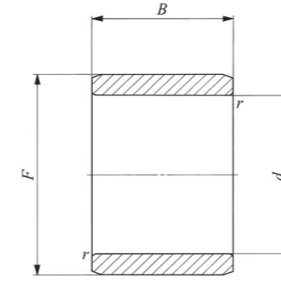

축지름 (mm)	Inner Rings		d (mm)	F (mm)	B (mm)	조합 Bearings	
	Koyo	IKO				Koyo	IKO
22	JR 22×26×16	LRT 222616	22	26	16	NK26/16	TAF263416
	-	IRT 2216	22	26	16.5	-	TA2616Z YT2616
	JR 22×26×20	LRT 222620	22	26	20	NK26/20	TAF263420
	-	IRT 2220	22	26	20.5	-	TA2620Z YT2620
	JR 22×28×17	LRT 222817	22	28	17	RNA49/22	RNA49/22
	-	LRTZ 222818	22	28	18	-	RNA49/22UU
	JR 22×28×20.5	IRT 2220-1	22	28	20.5	HK2820	TA2820Z TLA2820Z
	JR 22×28×30	LRT 222830	22	28	30	RNA69/22	RNA69/22
	-	IRT 2230-1	22	28	30.5	-	TA2830Z
	-	LRTZ 222831	22	28	31	-	RNA69/22UU
25	JR 25×29×20	LRT 252920	25	29	20	NK29/20	TAF293820
	-	IRT 2520	25	29	20.5	-	TA2920Z YT2920
	JR 25×29×30	LRT 252930	25	29	30	NK29/30	TAF293830
	-	IRT 2530	25	29	30.5	-	TA2930Z
	-	IRT 2515-1	25	30	15.5	-	TA3015Z
	JR 25×30×16	LRT 253016	25	30	16	RNAO304216	RNAF304216
	JR 25×30×16 JS1	-	25	30	16	-	-
	JR 25×30×17	LRT 253017	25	30	17	RNA4905 RNAO304017	RNA4905 RNAF304017
	JRZ 25×30×18 JS1	LRTZ 253018	25	30	18	RNA4905.2RS	RNA4905UU
	JR 25×30×20	LRT 253020	25	30	20	NAXK30 NAXR30	NAX3030 NBX3030
25	JR 25×30×20.5	IRT 2520-1	25	30	20.5	HK3020	TA3020Z TLA3020Z
	-	LRT 253025	25	30	25.5	-	TR304425
	-	LRTZ 253025	25	30	25.5	-	GTR304425
	-	IRT 2525-1	25	30	25.5	-	TA3025Z
	JR 25×30×26	LRT 253026	25	30	26	RNAO304026	RNAFW304026
	JR 25×30×26.5	IRT 2526-1	25	30	26.5	HK3026	TLA3026Z
	JR 25×30×30	LRT 253030	25	30	30	RNA6905	RNA6905
	-	IRT 2530-1	25	30	30.5	-	TA3030Z
	-	LRTZ 253031	25	30	31	-	RNA6905UU
	JR 25×30×32	LRT 253032	25	30	32	RNAO304232	RNAFW304232
JR 25×30×38.5	IRT 2538-1	25	30	38.5	HK3038	TLAW3038Z	
JR 25×32×22	-	25	32	22	NKS32A	-	

축지름 (mm)	Inner Rings		d (mm)	F (mm)	B (mm)	조합 Bearings	
	Koyo	IKO				Koyo	IKO
28	JR 28×32×17	LRT 283217	28	32	17	RNA49/28	RNA49/28
	-	LRTZ 283218	28	32	18	-	RNA49/28UU
	JR 28×32×20	LRT 283220	28	32	20	NK32/20	TAF324220
	-	IRT 2820	28	32	20.5	-	TA3220Z YT3220
	JR 28×32×20	LRT 283230	28	32	30	RNA69/28 NK32/30	RNA69/28 TAF324230
	-	LRTZ 283230	28	32	30.5	-	GTR324530
	-	IRT 2830	28	32	30.5	-	TA3230Z
	-	LRTZ 283231	28	32	31	-	RNA69/28UU
	-	IRT 3012	30	35	12.5	-	TA3512Z TLA3512Z
	-	IRT 3015	30	35	15.5	-	TA3515Z
30	JR 30×35×16	LRT 303516	30	35	16	RNAO354716	RNAF354716
	JR 30×35×17	LRT 303517	30	35	17	RNA4906 RNAO354517	RNA4906 RNAF354517
	JRZ 30×35×18 JS1	LRTZ 303518	30	35	18	RNA4906.2RS	RNA4906UU
	JR 30×35×20	LRT 303520	30	35	20	NK35/20 NAXK/NAXR35	TAF354520 NAX/NBX3530
	JRZ 30×35×20 JS1	-	30	35	20	-	-
	JR 30×35×20.5	IRT 3020	30	35	20.5	HK3520	TA3520Z TLA3520Z
	-	IRT 3025	30	35	25.5	-	TA3525Z
	JR 30×35×26	LRT 303526	30	35	26	RNAO354526	RNAFW354526
	JR 30×35×30	LRT 303530	30	35	30	RNA6906 NK35/30	RNA6906 TAF354530
	-	LRT 303530-1	30	35	30.5	-	TR354830
30	-	LRTZ 303530	30	35	30.5	-	GTR354830
	-	IRT 3030	30	35	30.5	-	TA3530Z
	-	LRTZ 303531	30	35	31	-	RNA6906UU
	JR 30×35×32	LRT 303532	30	35	32	RNAO354732	RNAFW354732
	JR 30×37×22	-	30	37	22	NKS37A	-
	JR 30×38×20 JS1	-	30	38	20	-	-

1.7 Inner Ring

Needle Roller Bearings

미리계열

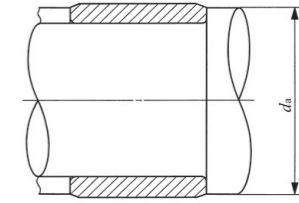
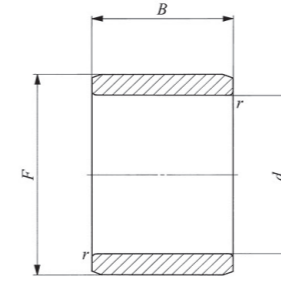

축지름 (mm)	Inner Rings		d (mm)	F (mm)	B (mm)	조합 Bearings	
	Koyo	IKO				Koyo	IKO
32	JR 32×37×20	LRT 323720	32	37	20	NK37/20	TAF374720
	-	IRT 3220	32	37	20.5	-	TA3720Z Y3720
	JR 32×37×30	LRT 323730	32	37	30	NK37/30	TAF374730
	-	IRT 3230	32	37	30.5	-	TA3730Z
	-	IRT 3215-1	32	38	15.5	-	TA3815Z
	-	IRT 3220-1	32	38	20.5	-	TA3820Z
	-	IRT 3225-1	32	38	25.5	-	TA3825Z
	-	LRT 323830	32	38	30.5	-	TR385230
	-	LRTZ 323830	32	38	30.5	-	GTR385230
	-	IRT 3230-1	32	38	30.5	-	TA3830Z
	-	IRT 3245-1	32	38	45.5	-	TAW3845Z
	JR 32×40×20	LRT 324020	32	40	20	RNA49/32	RNA49/32
	-	LRTZ 324021	32	40	21	-	RNA49/32UU
	JR 32×40×36	LRT 324036	32	40	36	RNA69/32	RNA69/32
	-	LRTZ 324037	32	40	37	-	RNA69/32UU

축지름 (mm)	Inner Rings		d (mm)	F (mm)	B (mm)	조합 Bearings	
	Koyo	IKO				Koyo	IKO
35	-	IRT 3515	35	40	15.5	-	TA4015Z Y4015
	JR 35×40×17	LRT 354017	35	40	17	RNAO405017	RNAF405017
	JR 35×40×20	LRT 354020	35	40	20	NK40/20 NAXK/NAXR40	TAF405020 NAX/NBX4032
	-	LRTZ 354020	35	40	20.5	-	GTR405520
	JR 35×40×20.5	IRT 3520	35	40	20.5	HK4020	TA4020Z TLA4020Z
	JR 35×40×22	-	35	40	22	-	-
	-	IRT 3525	35	40	25.5	-	TA4025Z Y4025
	JR 35×40×30	LRT 354030	35	40	30	NK40/30	TAF405030
	-	IRT 3530	35	40	30.5	-	TA4030Z
	JR 35×40×34	LRT 354034	35	40	34	RNAO405034	RNAFW405034
	JR 35×40×40	LRT 354040	35	40	40	RNAO405540	RNAFW405540
	-	IRT 3540	35	40	40.5	-	TA4040Z
	JR 35×42×20	LRT 354220	35	42	20	RNA4907	RNA4907
	JR 35×42×20 JS1	-	35	42	20	-	-
	-	LRTZ 354221	35	42	21	-	RNA4907UU
	JRZ 35×42×23 JS1	-	35	42	23	-	-
	-	LRT 354230	35	42	30.5	-	TR425630
	-	LRTZ 354230	35	42	30.5	-	GTR425630
	JR 35×42×36	LRT 354236	35	42	36	RNA6907	RNA6907
	-	LRTZ 354237	35	42	37	-	RNA6907UU
JR 35×43×22	-	35	43	22	NKS43A	-	
JR 35×44×22	-	35	44	22	-	-	
38	JR 38×43×20	LRT 384320	38	43	20	NK43/20	TAF435320
	JR 38×43×30	LRT 384330	38	43	30	NK43/30	TAF435330

1.7 Inner Ring

Needle Roller Bearings

미리계열

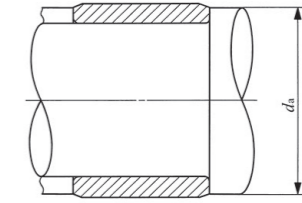
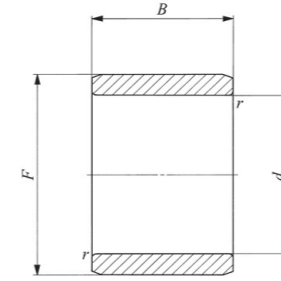

축지름 (mm)	Inner Rings		d (mm)	F (mm)	B (mm)	조합 Bearings	
	Koyo	IKO				Koyo	IKO
40	JR 40×45×17	LRT 404517	40	45	17	RNAO455517	RNAF455517
	JR 40×45×20	LRT 404520	40	45	20	NK45/20 NAXK/NAXR45	TAF455520 NAX/NBX4532
	JR 40×45×20.5	IRT 4020	40	45	20.5	HK4520	TA4520Z TLA4520Z
	-	IRT 4025	40	45	25.5	-	TA4525Z YT4525
	JR 40×45×30	LRT 404530	40	45	30	NK45/30	TAF455530
	-	LRT 404530-1	40	45	30.5	-	TR455930
	-	LRTZ 404530	40	45	30.5	-	GTR455930
	-	IRT 4030	40	45	30.5	-	TA4530Z
	JR 40×45×34	LRT 404534	40	45	34	RNAO455534	RNAFW455534
	JR 40×45×40	LRT 404540	40	45	40	RNAO456240	RNAFW456240
	-	IRT 4040	40	45	40.5	-	TA4540Z
	JR 40×48×22	LRT 404822	40	48	22	RNA4908	RNA4908
	JRZ 40×48×23 JS1	LRTZ 404823	40	48	23	RNA4908.2RS	RNA4908UU
	JR 40×48×40	LRT 404840	40	48	40	RNA6908	RNA6908
	-	LRTZ 404841	40	48	41	-	RNA6908UU
	JR 40×50×20	-	40	50	20	-	-
	JR 40×47×30	-	40	50	22	NKS50A	-
	42	JR 42×47×20	LRT 424720	42	47	20	NK47/20
JR 42×47×30		LRT 424730	42	47	30	NK47/30	TAF475730
-		LRT 424830	42	48	30.5	-	TR486230
-	LRTZ 424830	42	48	30.5	-	GTR486230	

축지름 (mm)	Inner Rings		d (mm)	F (mm)	B (mm)	조합 Bearings	
	Koyo	IKO				Koyo	IKO
45	-	IRT 4512	45	50	12.5	-	TA5012Z
	-	IRT 4515	45	50	15.5	-	TA5015Z
	JR 45×50×20	LRT 455020	45	50	20	RNAO506220	RNAF506220
	-	IRT 4520	45	50	20.5	-	TA5020Z TLA5020Z
	JR 45×50×25	LRT 455025	45	50	25	NK50/25 NAXK/NAXR50	TAF506225 NAX/NBX5035
	JR 45×50×25.5	IRT 4525	45	50	25.5	HK5025	TA5025Z TLA5025Z
	-	LRT 455030	45	50	30.5	-	TR506430
	-	LRTZ 455030	45	50	30.5	-	GTR506430
	-	IRT 4530	45	50	30.5	-	TA5030Z
	JR 45×50×35	LRT 455035	45	50	35	NK50/35	TAF506235
	JR 45×50×40	LRT 455040	45	50	40	RNAO506240	RNAFW506240
	-	IRT 4540	45	50	40.5	-	TA5040Z
	-	IRT 4545	45	50	45.5	-	TAW5045Z
	JR 45×52×22	LRT 455222	45	52	22	RNA4909	RNA4909
	JR 45×52×23 JS1	LRTZ 455223	45	52	23	RNA4909.2RS	RNA4909UU
	JR 45×52×40	LRT 455240	45	52	40	RNA6909	RNA6909
	-	LRTZ 455241	45	52	41	-	RNA6909UU
	JR 45×55×20	LRT 455520	45	55	20	RNAO557220	RNAF557220
	JR 45×55×20 JS1	-	45	55	20	-	-
	JR 45×55×22	-	45	55	22	NKS55A	-
JR 45×55×40	LRT 455540	45	55	40	RNAO557240	RNAFW557240	

1.7 Inner Ring

Needle Roller Bearings

미리계열

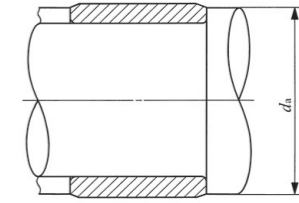
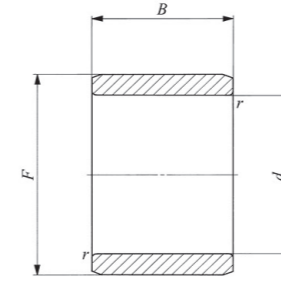

축지름 (mm)	Inner Rings		d (mm)	F (mm)	B (mm)	조합 Bearings	
	Koyo	IKO				Koyo	IKO
50	JR 50×55×20	LRT 505520	50	55	20	RNAO556820	RNAF556820
	-	IRT 5020-1	50	55	20.5	-	TA5520Z TLA5520Z
	JR 50×55×25	LRT 505525	50	55	25	NK55/25	TAF556825
	-	IRT 5025-1	50	55	25.5	-	TA5525Z TLA5525Z
	-	IRT 5030-1	50	55	30.5	-	TA5530Z
	JR 50×55×35	LRT 505535	50	55	35	NK55/35	TAF556835
	JR 50×55×40	LRT 505540	50	55	40	RNAO556840	RNAFW556840
	-	IRT 5040-1	50	55	40.5	-	TA5540Z
	-	IRT 5045-1	50	55	45.5	-	TAW5545Z
	-	IRT 5050-1	50	55	50.5	-	TAW5550Z
	JR 50×58×22	LRT 505822	50	58	22	RNA4910	RNA4910
	JRZ 50×58×23JS1	LRTZ 505823	50	58	23	RNA4910.2RS	RNA4910UU
	JR 50×58×40	LRT 505840	50	58	40	RNA6910	RNA6910
	-	LRTZ 505841	50	58	41	-	RNA6910UU
	-	LRT 505845	50	58	45.5	-	TR587745
	-	LRTZ 505845	50	58	45.5	-	GTR587745
	JR 50×60×20	LRT 506020	50	60	20	RNAO607820	RNAF607820
	JR 50×60×20JS1	-	50	60	20	-	-
	JR 50×60×25	LRT 506025	50	60	25	NAXK60 NAXR60	NAX6040 NBX6040
	-	IRT 5025	50	60	25.5	-	TA6025Z
JR 50×60×28	-	50	60	28	NKS60A	-	
-	IRT 5030	50	60	30.5	-	TA6030Z	
JR 50×60×40	LRT 506040	50	60	40	RNAO607840	RNAFW607840	
-	IRT 5040	50	60	40.5	-	TA6040Z	
-	IRT 5045	50	60	45.5	-	TAW6045Z	
-	IRT 5050	50	60	55.5	-	TAW6050Z	
52	-	IRT 5212	52	62	12.5	-	TA6212Z

축지름 (mm)	Inner Rings		d (mm)	F (mm)	B (mm)	조합 Bearings	
	Koyo	IKO				Koyo	IKO
55	JR 55×60×25	LRT 556025	55	60	25	NK60/25	TAF607225
	JR 55×60×35	LRT 556035	55	60	35	NK60/35	TAF607235
	-	LRT 556238	55	62	38.5	-	TR628138
	-	LRTZ 556238	55	62	38.5	-	GTR628138
	JR 55×63×25	LRT 556325	55	63	25	RNA4911	RNA4911
	-	LRTZ 556326	55	63	26	-	RNA4911UU
	JR 55×63×45	LRT 556345	55	63	45	RNA6911	RNA6911
	-	LRTZ 556346	55	63	46	-	RNA6911UU
	-	IRT 5525	55	65	25.5	-	TA6525Z
	JR 55×65×28	-	55	65	28	NKS65A	-
	JR 55×65×30	LRT 556530	55	65	30	RNAO658530	RNAF658530
	-	IRT 5530	55	65	30.5	-	TA6530Z
	-	IRT 5545	55	65	45.5	-	TAW6545Z
	-	IRT 5550	55	65	50.5	-	TAW6550Z
	JR 55×65×60	LRT 556560	55	65	60	RNAO658560	RNAFW658560
	JR 60×68×25	LRT 606825	60	68	25	NK68/25 RNA4912	TAF688225 RNA4912
	-	LRTZ 606826	60	68	26	-	RNA4912UU
	JR 60×68×35	LRT 606835	60	68	35	NK68/35	TAF688235
	JR 60×68×45	LRT 606845	60	68	45	RNA6912	RNA6912
	-	LRTZ 606846	60	68	46	-	RNA6912UU
JR 60×70×25	-	60	70	25	-	-	
-	LRT 607025	60	70	25.5	-	NAX7040	
-	IRT 6025	60	70	25.5	-	TA7025Z	
JR 60×70×28	-	60	70	28	NKS70A	-	
JR 60×70×30	LRT 607030	60	70	30	RNAO709030	RNAF709030	
-	IRT 6030	60	70	30.5	-	TA7030Z	
-	IRT 6040	60	70	40.5	-	TA7040Z	
-	LRT 607045	60	70	45.5	-	TR708945	
-	LRTZ 607045	60	70	45.5	-	GTR708945	
-	IRT 6050	60	70	50.5	-	TAW7050Z	
JR 60×70×60	LRT 607060	60	70	60	RNAO709060	RNAFW709060	

1.7 Inner Ring

Needle Roller Bearings

미리계열

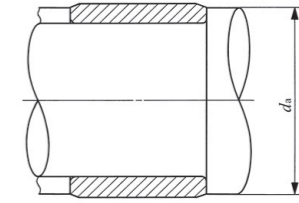
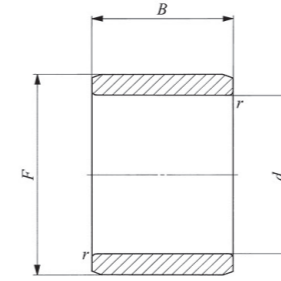

축지름 (mm)	Inner Rings		d (mm)	F (mm)	B (mm)	조합 Bearings			
	Koyo	IKO				Koyo	IKO		
65	JR 65×72×25	LRT 657225	65	72	25	RNA4913	RNA4913		
	-	LRTZ 657226	65	72	26	-	RNA4913UU		
	JR 65×72×45	LRT 657245	65	72	45	RNA6913	RNA6913		
	-	LRTZ 657246	65	72	46	-	RNA6913UU		
	JR 65×73×25	-	65	73	25	NK73/25	-		
	JR 65×73×35	LRT 657335	65	73	35	NK73/35	TAF739035		
	JR 65×75×28	-	65	75	28	NKS75A	-		
	JR 65×75×30	LRT 657530	65	75	30	RNAO759530	RNAF759530		
	JR 65×75×60	LRT 657560	65	75	60	RNAO759560	RNAFW759560		
	70	JR 70×80×25	LRT 708025	70	80	25	NK80/25	TAF809525	
JR 70×80×28		-	70	80	28	NKS80A	-		
JR 70×80×30		LRT 708030	70	80	30	RNA4914	RNAO8010030	RNA4914	RNAF8010030
-		LRTZ 708031	70	80	31	-	RNA4914UU		
JR 70×80×35		LRT 708035	70	80	35	NK80/35	TAF809535		
JR 70×80×54		LRT 708054	70	80	54	RNA6914	RNA6914		
-		LRTZ 708055	70	80	55	-	RNA6914UU		
JR 70×80×60		LRT 708060	70	80	60	RNAO8010060	-		
75	-	LRT 758345	75	83	45.5	-	TR8310845		
	-	LRTZ 758345	75	83	45.5	-	GTR8310845		
	JR 75×85×25	LRT 758525	75	85	25	NK85/25	TAF8510525		
	JR 75×85×30	LRT 758530	75	85	30	RNA4915	RNAO8510530	RNA4915	RNAF8510530
	-	LRTZ 758531	75	85	31	-	RNA4915UU		
	JR 75×85×35	LRT 758535	75	85	35	NK85/35	TAF8510535		
	JR 75×85×54	LRT 758554	75	85	54	RNA6915	RNA6915		
	-	LRTZ 758555	75	85	55	-	RNA6915UU		
	JR 75×90×32	-	75	90	32	NKS90A	-		

축지름 (mm)	Inner Rings		d (mm)	F (mm)	B (mm)	조합 Bearings	
	Koyo	IKO				Koyo	IKO
80	JR 80×90×25	LRT 809025	80	90	25	NK90/25	TAF9011025
	JR 80×90×30	LRT 809030	80	90	30	RNA4916	RNA4916 RNAF9011030
	-	LRTZ 809031	80	90	31	-	RNA4916UU
	JR 80×90×35	LRT 809035	80	90	35	NK90/35	TAF9011035
	JR 55×63×54	LRT 809054	80	90	54	RNA6916	RNA6916
	-	LRT 809055	80	90	55	-	RNA6916UU
	JR 80×95×32	-	80	95	32	NKS95A	-
	-	LRT 859350	85	93	50.5	-	TR9311850
	-	LRTZ 859350	85	93	50.5	-	GTR9311850
	85	JR 85×95×26	LRT 859526	85	95	26	NK95/26
JR 85×95×30		LRT 859530	85	95	30	RNAO9511530	RNAF9511530
JR 85×95×36		LRT 859536	85	95	36	NK95/36	TAF9511536
-		LRT 859545	85	95	45.5	-	TR9512045
-		LRTZ 859545	85	95	45.5	-	GTR9512045
JR 85×100×35		LRT 8510035	85	100	35	RNA4917	RNA4917
-		LRTZ 8510036	85	100	36	-	RNA4917UU
JR 85×100×63		LRT 8510063	85	100	63	RNA6917	RNA6917
-		LRTZ 8510064	85	100	64	-	RNA6917UU
90		JR 90×100×26	LRT 9010026	90	100	26	NK100/26
	JR 90×100×30	LRT 9010030	90	100	30	RNAO10012030	RNAF10012030
	JR 90×100×36	LRT 9010036	90	100	36	NK100/36	TAF10012036
	-	LRT 9010050	90	100	50.5	-	TR10012550
	-	LRTZ 9010050	90	100	50.5	-	GTR10012550
	JR 90×105×32	-	90	105	32	-	-
	JR 90×105×35	LRT 9010535	90	105	35	RNA4918	RNA4918
	-	LRTZ 9010536	90	105	36	-	RNA4918UU
	JR 90×105×63	LRT 9010563	90	105	63	RNA6918	RNA6918
	-	LRTZ 9010564	90	105	64	-	RNA6918UU

1.7 Inner Ring

Needle Roller Bearings

미리계열

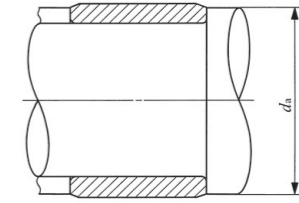
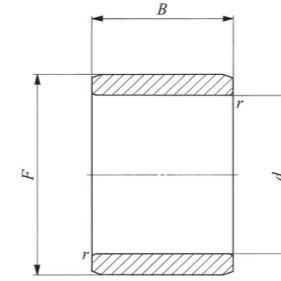

축지름 (mm)	Inner Rings		d (mm)	F (mm)	B (mm)	조합 Bearings	
	Koyo	IKO				Koyo	IKO
95	JR 95×105×26	LRT 9510526	95	105	26	NK105/26	TAF10512526
	JR 95×105×36	LRT 9510536	95	105	36	NK105/36	TAF10512536
	JR 95×110×35	LRT 9511035	95	110	35	RNA4919	RNA4919
	-	LRTZ 9511036	95	110	36	-	RNA4919UU
	JR 95×110×63	LRT 9511063	95	110	63	RNA6919	RNA6919
-	LRTZ 9511064	95	110	64	-	RNA6919UU	
100	JR 100×110×30	LRT 10011030	100	110	30	NK110/30	TAF11013030
	JR 100×110×40	LRT 10011040	100	110	40	NK110/40	TAF11013040
	-	LRT 10011050	100	110	50.5	-	TR11013550
	-	LRTZ 10011050	100	110	50.5	-	GTR11013550
	JR 100×115×32	-	-	-	-	NKS115A	-
-	LRTZ 10011541	100	115	41	-	RNA4920UU	
105	-	LRT 10511550	105	115	50.5	-	TR11515350
	-	LRTZ 10511550	105	115	50.5	-	GTR11515350
110	JR 110×120×30	LRT 11012030	110	120	30	RNA4822	RNA4822
	JR 110×125×40	LRT 11012540	110	125	40	RNA4922	RNA4922
	-	LRTZ 11012541	110	125	41	-	RNA4922UU
120	JR 120×130×30	LRT 12013030	120	130	30	RNA4824	RNA4824
	JR 120×135×45	LRT 12013545	120	135	45	RNA4924	RNA4924
	-	LRTZ 12013546	120	135	46	-	RNA4924UU
125	-	LRT 12514060	125	140	60.5	-	TR14017860
	-	LRTZ 12514060	125	140	60.5	-	GTR14017860
130	JR 130×145×35	LRT 13014535	130	145	35	RNA4826	RNA4826
	JR 130×150×50	LRT 13015050	130	150	50	RNA4926	RNA4926
	-	LRTZ 13015051	130	150	51	-	RNA4926UU
135	-	LRT 13515060	135	150	60.5	-	TR15018860
	-	LRTZ 13515060	135	150	60.5	-	GTR15018860
140	JR 140×155×35	LRT 14015535	140	155	35	RNA4828	RNA4828
	JR 140×160×50	LRT 14016050	140	160	50	RNA4928	RNA4928
	-	LRTZ 14016051	140	160	51	-	RNA4928UU

축지름 (mm)	Inner Rings		d (mm)	F (mm)	B (mm)	조합 Bearings	
	Koyo	IKO				Koyo	IKO
150	JR 150×165×40	LRT 15016540	150	165	40	RNA4830	RNA4830
	-	LRT 15017060	150	170	60	-	RNA4930
160	JR 160×175×40	LRT 16017540	160	175	40	RNA4832	RNA4832
	-	LRT 16018060	160	180	60	-	RNA4932
170	JR 170×185×45	LRT 17018545	170	185	45	RNA4834	RNA4834
	-	LRT 17019060	170	190	60	-	RNA4934
180	JR 180×195×45	LRT 18019545	180	195	45	RNA4836	RNA4836
	-	LRT 18020569	180	205	69	-	RNA4936
190	-	LRT 19021050	190	210	50	-	RNA4838
	-	LRT 19021569	190	215	69	-	RNA4938
200	-	LRT 20022050	200	220	50	-	RNA4840
	-	LRT 20022580	200	225	80	-	RNA4940
220	-	LRT 22024050	220	240	50	-	RNA4844
	-	LRT 22024580	220	245	80	-	RNA4944
240	-	LRT 24026560	240	265	60	-	RNA4848
	-	LRT 24026580	240	265	80	-	RNA4948
260	-	LRT 26028560	260	285	60	-	RNA4852
	-	LRT 260290100	260	290	100	-	RNA4952
280	-	LRT 28030569	280	305	69	-	RNA4856
	-	LRT 280310100	280	310	100	-	RNA4956
300	-	LRT 30033080	300	330	80	-	RNA4860
	-	LRT 300340118	300	340	118	-	RNA4960
320	-	LRT 32035080	320	350	80	-	RNA4864
	-	LRT 320360118	320	360	118	-	RNA4964
340	-	LRT 34037080	340	370	80	-	RNA4868
	-	LRT 340380118	340	380	118	-	RNA4968
360	-	LRT 36039080	360	390	80	-	RNA4872
	-	LRT 360400118	360	400	118	-	RNA4972
380	-	LRT 380415100	380	415	100	-	RNA4876
	-	LRT 380430140	380	430	140	-	RNA4976
400	-	LRT 400450140	400	450	140	-	RNA4980
420	-	LRT 420470140	420	470	140	-	RNA4984
440	-	LRT 440490160	440	490	160	-	RNA4988